

ŞUBAT 2024  
FİYAT LİSTESİ

# AŞMAN



[www.asmanfittings.com](http://www.asmanfittings.com)

1959-2024

Türkiye'nin her köşesinde mutlaka bir AŞMAN Döküm ürünü vardır...

# AŞMAN



[www.asmanvana.com](http://www.asmanvana.com)



**AŞMAN**®  
DÖKÜM SANAYİ VE TİCARET A.Ş.

[www.asman.com.tr](http://www.asman.com.tr)

Her hakkı saklıdır. İzinsiz çoğaltılamaz, dağıtılamaz ve amacı dışında kullanılamaz.  
Copyright © 2021 Aşman Döküm Sanayi ve Ticaret A.Ş.



**AŞMAN**<sup>®</sup>  
DÖKÜM SANAYİ VE TİCARET A.Ş.



**AŞMAN**<sup>®</sup>  
KÜRESEL VANA  
PİSLİK TUTUCU - ÇEKVALF

**AŞMAN**  
KÜRESEL VANA  
PİSLİK TUTUCU - ÇEKVALF

SEKTÖRÜNDE TÜRKİYE'NİN  
LİDER KURULUŞU

DURAK TİCARET





Türkiye'nin her köşesinde mutlaka bir AŞMAN Döküm ürünü vardır...

<b>DİRSEK (SFERO)</b>		1/2"	3/4"	1"	1 1/4"	1 1/2"	2"	2 1/2"	3"	4"	5"	6"
 Kod No.S-1	SİYAH	15,00	22,00	35,00	75,00	110,00	160,00	225,00	280,00	420,00	950,00	1250,00
	GALV.	25,00	40,00	50,00	100,00	130,00	190,00	275,00	340,00	510,00	1150,00	1450,00
	KOLİ ADET					80	80	60	50	20	10	6

<b>TE (SFERO)</b>		1/2"	3/4"	1"	1 1/4"	1 1/2"	2"	2 1/2"	3"	4"	5"	6"
 Kod No.S-2	SİYAH	22,00	35,00	50,00	95,00	150,00	200,00	270,00	330,00	500,00	1100,00	1500,00
	GALV.	30,00	50,00	65,00	115,00	180,00	240,00	325,00	400,00	610,00	1300,00	1800,00
	KOLİ ADET					80	80	60	50	20	10	6

<b>ISTAVROZ (SFERO)</b>		1/2"	3/4"	1"	1 1/4"	1 1/2"	2"	2 1/2"	3"	4"	5"	6"
 Kod No.S-3	SİYAH	75,00	115,00	140,00	180,00	230,00	250,00	350,00	450,00	900,00		
	GALV.	100,00	145,00	180,00	215,00	275,00	300,00	390,00	510,00	1070,00		
	KOLİ ADET					80	80	60	50	20		

<b>NİPEL (SFERO)</b>		1/2"	3/4"	1"	1 1/4"	1 1/2"	2"	2 1/2"	3"	4"	5"	6"
 Kod No.S-4	SİYAH	15,00	20,00	30,00	50,00	60,00	80,00	100,00	150,00	240,00	350,00	450,00
	GALV.	20,00	25,00	35,00	55,00	70,00	95,00	120,00	180,00	290,00	410,00	550,00
	KOLİ ADET			150	120	100	100	60	60	40	20	15

<b>KONİK REKOR (SFERO)</b>		1/2"	3/4"	1"	1 1/4"	1 1/2"	2"	2 1/2"	3"	4"	5"	6"
 Kod No.S-5	SİYAH	85,00	100,00	165,00	190,00	250,00	300,00	500,00	650,00	900,00		
	GALV.	115,00	130,00	215,00	240,00	325,00	375,00	600,00	750,00	1000,00		
	KOLİ ADET					50	40	30	30	20		

<b>DEVE BOYNU (SFERO)</b>		1"	1 1/4"	1 1/2"	2"	2 1/2"	3"	4"	5"	6"
 Kod No.S-6	SİYAH	110,00	140,00	180,00	250,00	350,00	500,00	750,00	1300,00	1600,00
	GALV.	130,00	170,00	220,00	240,00	430,00	600,00	900,00	1550,00	1900,00
	KOLİ ADET	40	30	30	25	15	10	10	4	4

<b>KUYRUKLU DİRSEK (SFERO)</b>		1/2"	3/4"	1"	1 1/4"	1 1/2"	2"	2 1/2"	3"	4"	5"	6"
 Kod No.S-7	SİYAH	20,00	30,00	45,00	82,00	120,00	155,00	385,00	500,00	850,00		
	GALV.	22,00	33,00	49,00	90,00	135,00	185,00	425,00	550,00	940,00		
	KOLİ ADET					50	30	20	15	10		

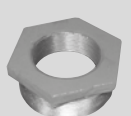
<b>NİPEL REDİKSİYON (SFERO)</b>		2x1/2"	2x3/4"	2x1	2x1 1/4"	2x1 1/2"	2 1/2"x1	2 1/2"x1 1/4"	2 1/2"x1 1/2"	2 1/2"x2
 Kod No.S-8	SİYAH	90,00	90,00	85,00	80,00	75,00	150,00	135,00	125,00	115,00
	GALV.	110,00	110,00	100,00	95,00	90,00	170,00	155,00	145,00	135,00
	KOLİ ADET	50	50	50	60	75	50	50	50	60
		3x1	3x1 1/4"	3x1 1/2"	3x2	3x2 1/2"	4x1	4x1 1/4"	4x1 1/2"	4x2
	SİYAH	160,00	150,00	140,00	130,00	120,00	250,00	235,00	225,00	215,00
	GALV.	190,00	180,00	170,00	160,00	145,00	300,00	280,00	245,00	255,00
	KOLİ ADET	40	40	40	40	50	30	30	30	30
		4x2 1/2"	4x3	5x2	5x2 1/2"	5x3	5x4	6x3	6x4	6x5
	SİYAH	205,00	195,00	360,00	330,00	300,00	260,00	450,00	460,00	400,00
	GALV.	245,00	230,00	440,00	410,00	375,00	310,00	530,00	545,00	475,00
	KOLİ ADET	40	40	20	20	20	25	10	10	10

**AŞMAN SFERO FITTINGS**

<b>MANŞON REDİKSİYON (SFERO)</b>		2x1 <sup>1</sup> / <sub>4</sub> "	2x1 <sup>1</sup> / <sub>2</sub> "	2 <sup>1</sup> / <sub>2</sub> "x1 <sup>1</sup> / <sub>2</sub> "	2 <sup>1</sup> / <sub>2</sub> "x2	3x1 <sup>1</sup> / <sub>2</sub> "	3x2	3x2 <sup>1</sup> / <sub>2</sub> "	4x1 <sup>1</sup> / <sub>2</sub> "	4x2	
 <p>Kod No.S-9</p>	SİYAH	110,00	120,00	160,00	170,00	180,00	190,00	200,00	250,00	260,00	
	GALV.	125,00	140,00	185,00	200,00	215,00	225,00	240,00	300,00	310,00	
	KOLİ ADET	40	40	30	30	25	25	25	20	20	
		4x2 <sup>1</sup> / <sub>2</sub> "	4x3	5x4	6x4	6x5					
	SİYAH	270,00	280,00	380,00	410,00	420,00					
	GALV.	330,00	340,00	460,00	500,00	510,00					
	KOLİ ADET	20	20	15	10	10					

<b>NİPEL MANŞON REDİKSİYON (SFERO)</b>		2x1 <sup>1</sup> / <sub>2</sub> "	2 <sup>1</sup> / <sub>2</sub> "x1 <sup>1</sup> / <sub>2</sub> "	2 <sup>1</sup> / <sub>2</sub> "x2	3x2	3x2 <sup>1</sup> / <sub>2</sub> "	4x2 <sup>1</sup> / <sub>2</sub> "	4X3	5X4	6X4	6X5
 <p>Kod No.S-10</p>	SİYAH	110,00	160,00	170,00	190,00	200,00	265,00	250,00	360,00	450,00	480,00
	GALV.	130,00	190,00	200,00	220,00	240,00	325,00	310,00	430,00	540,00	580,00
	KOLİ ADET	60	50	50	40	40	30	30	20	15	15

<b>KONSANTRİK NİPEL (SFERO)</b>		2x1 <sup>1</sup> / <sub>2</sub> "	2 <sup>1</sup> / <sub>2</sub> "x2	3x2	3x2 <sup>1</sup> / <sub>2</sub> "	4x3
 <p>Kod No.S-11</p>	SİYAH	130,00	160,00	190,00	210,00	310,00
	GALV.	150,00	185,00	220,00	240,00	370,00
	KOLİ ADET	40	30	25	25	20

<b>TAPA (SFERO)</b>		1/2"	3/4"	1"	1 <sup>1</sup> / <sub>4</sub> "	1 <sup>1</sup> / <sub>2</sub> "	2"	2 <sup>1</sup> / <sub>2</sub> "	3"	4"	5"	6"
 <p>Kod No.S-12</p>	SİYAH	12,00	16,00	20,00	50,00	60,00	70,00	100,00	150,00	170,00	300,00	400,00
	GALV.	15,00	20,00	25,00	60,00	70,00	85,00	115,00	175,00	205,00	350,00	490,00
	KOLİ ADET				100	100	100	60	60	30	20	15

<b>TERS TAPA (SFERO)</b>		1"	1 <sup>1</sup> / <sub>4</sub> "	1 <sup>1</sup> / <sub>2</sub> "	2"	2 <sup>1</sup> / <sub>2</sub> "	3"	4"	5"	6"
 <p>Kod No.S-13</p>	SİYAH		55,00	70,00	90,00	120,00	160,00	210,00	280,00	370,00
	GALV.		65,00	85,00	105,00	140,00	190,00	250,00	340,00	460,00
	KOLİ ADET		100	100	100	60	60	30	20	15

<b>DÖKÜM FLANÇ (SFERO)</b>		1"	1 <sup>1</sup> / <sub>4</sub> "	1 <sup>1</sup> / <sub>2</sub> "	2"	2 <sup>1</sup> / <sub>2</sub> "	3"	4"	5"	6"
 <p>Kod No.S-14</p>	SİYAH	130,00	140,00	170,00	200,00	230,00	300,00	350,00	400,00	500,00
	GALV.	160,00	165,00	200,00	240,00	290,00	370,00	435,00	505,00	650,00
	KOLİ ADET	40	40	30	30	25	25	20	10	10

<b>KELEBEK VANA FLANÇI (SFERO)</b>		1"	1 <sup>1</sup> / <sub>4</sub> "	1 <sup>1</sup> / <sub>2</sub> "	2"	2 <sup>1</sup> / <sub>2</sub> "	3"	4"	5"	6"
 <p>Kod No.S-15</p>	SİYAH	140,00	150,00	180,00	220,00	260,00	330,00	380,00	430,00	530,00
	GALV.	160,00	185,00	210,00	260,00	320,00	420,00	485,00	555,00	700,00
	KOLİ ADET	40	40	30	30	25	25	20	10	10

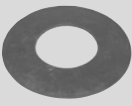
<b>KFLANÇ LASTİĞİ</b>		1 <sup>1</sup> / <sub>4</sub> "	1 <sup>1</sup> / <sub>2</sub> "	2"	2 <sup>1</sup> / <sub>2</sub> "	3"	4"	5"	6"
 <p>Kod No.KL-2</p>			20,00	25,00	30,00	35,00	50,00	60,00	70,00

**PN 16 Y TİPİ FLANÇLI PİSLİK TUTUCU**

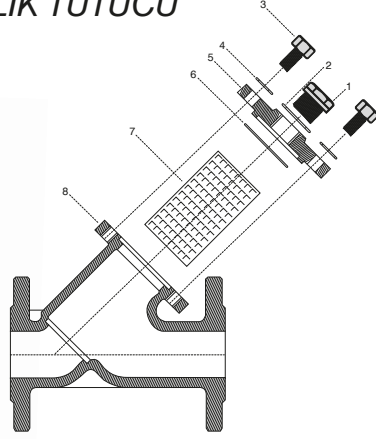

PN 16 Y TİPİ FLANÇLI PİSLİK TUTUCU									
DN	BOYUTLAR TS 11494		BAĞLANTI TS ISO 7005-2						
	L	d	g	k	D	l	b	f	Delik sayısı
40	200	40	84	110	150	19	18	3	4
50	230	50	99	125	165	19	20	3	4
65	290	65	118	145	185	19	20	3	4
80	310	80	132	160	200	19	22	3	8
100	350	100	156	180	220	19	24	3	8
125	400	125	184	210	250	19	26	3	8
150	480	150	211	240	285	23	26	3	8

**PN 16 T TİPİ FLANÇLI PİSLİK TUTUCU**

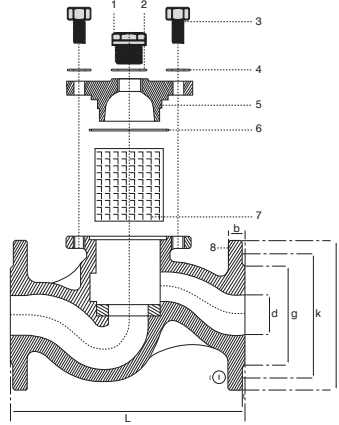

PN 16 T TİPİ FLANÇLI PİSLİK TUTUCU									
DN	BOYUTLAR TS 11494		BAĞLANTI TS ISO 7005-2						
	L	d	g	k	D	l	b	f	Delik sayısı
40	200	40	84	110	150	19	18	3	4
50	230	50	99	125	165	19	20	3	4
65	290	65	118	145	185	19	20	3	4
80	310	80	132	160	200	19	22	3	8
100	350	100	156	180	220	19	24	3	8
125	400	125	184	210	250	19	26	3	8
150	480	150	211	240	285	23	26	3	8

**PN 16 TAM GEÇİŞLİ KÜRESEL VANA F4 (2 PARÇALI)**

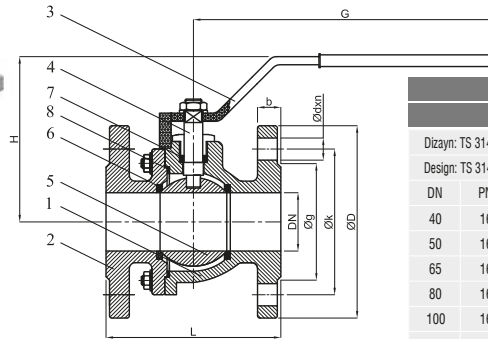
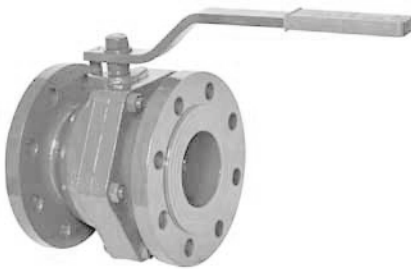

PN 16 TAM GEÇİŞLİ KÜRESEL VANA F4 (2 PARÇALI)											
PN 16 FULL BORE BALL VALVE F4 (2 PIECES)											
Design: TS 3148	Vana Boyutları: TS EN 558 Seri 14	PN 16 Flanş Boyutları: TS EN 1092-2						Delik Adedi	Ağırlık		
Design: TS 3148	Valve Dimensions: EN 558 Serial 14	PN 16 Flange Dimensions: EN 1092-2						Hole Qty	Weight		
DN	PN	L	H	G	D	k	g	b	d	n	Kg
40	16	140	130	255	150	110	84	18	19	4	7,00
50	16	150	142	255	165	125	99	20	19	4	8,70
65	16	170	150	255	185	145	118	20	19	4	12,10
80	16	180	161	305	200	160	132	22	19	8	16,50
100	16	190	172	305	220	180	156	24	19	8	20,20
125	16	200	240	430	250	210	184	26	19	8	30,20
150	16	210	268	430	285	240	211	26	23	8	35,00

**PN 16 DAR GEÇİŞLİ FLANŞLI KÜRESEL VANA**

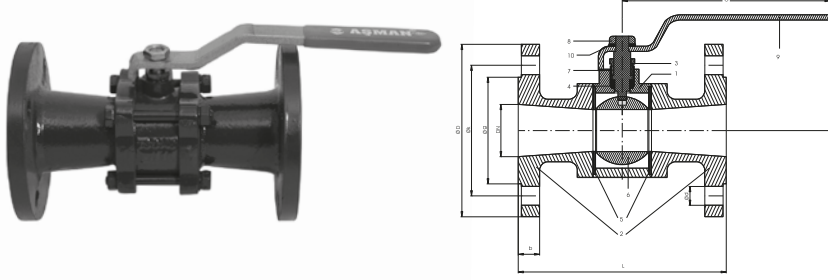

PN 16 Dar Geçişli Flanşlı Küresel Vana Boyutları - Bağlantı Ölçüleri									
Anma Çapı	Vana Boyutları			FLANS Ölçüleri TS810 - PN16 - DIN 2501					
DN	L	G <sub>max</sub>	H <sub>max</sub>	ØD	Øk	Øg	b	Ød	Delik Adedi
DN50	230	300	111	165	125	102	20	18	4
DN65	290	320	114	185	145	122	20	18	4
DN80	310	350	132	200	160	138	22	18	8
DN100	350	450	145	220	180	158	24	20	8
DN125	400	500	153	250	210	188	26	20	8

**PN 16 TAM GEÇİŞLİ FLANŞLI KÜRESEL VANA**

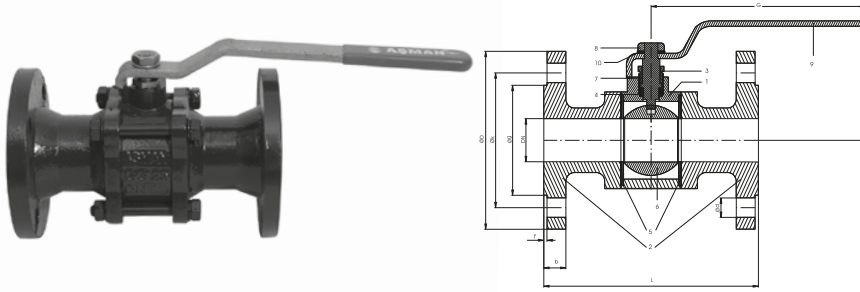

PN 16 Tam Geçişli Flanşlı Küresel Vana Boyutları - Bağlantı Ölçüleri									
Anma Çapı	Vana Boyutları			FLANS Ölçüleri TS810 - PN16 - DIN 2501					
DN	L	G <sub>max</sub>	H <sub>max</sub>	ØD	Øk	Øg	b	Ød	Delik Adedi
DN40	200	300	105	150	110	88	18	18	4
DN50	230	320	114	165	125	102	20	18	4
DN65	290	350	132	185	145	122	20	18	4
DN80	310	450	145	200	160	138	22	18	8
DN100	350	500	153	220	180	158	24	20	8

**DAR GEÇİŞLİ PASOLU KÜRESEL VANA**

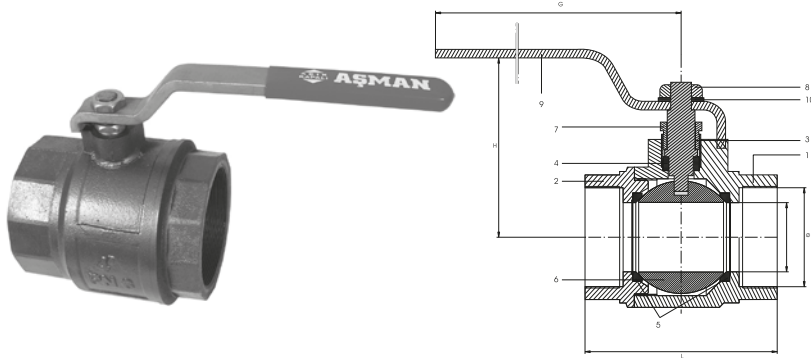





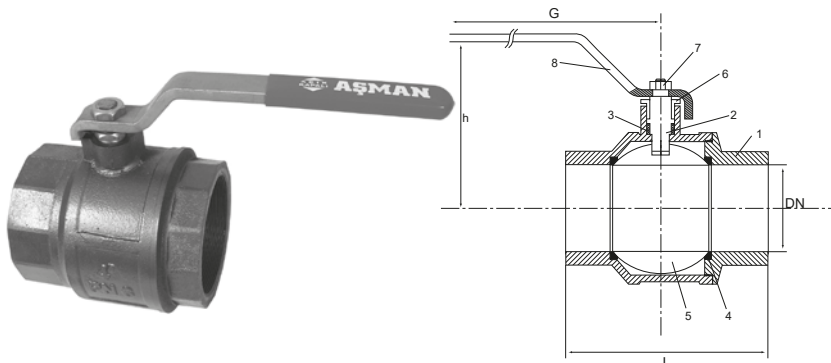

PN 10/16 Dar Geçişli-Dişi Küresel Vana Boyutları-Bağlantı Ölçüleri				
Ø	DN	L	H	G
2"	40	111	104	230
2 1/2"	50	124	109	250
3"	65	146	120	250
4"	80	165	132	320
5"	100	210	140	320
6"	125	255	231	420

**TAM GEÇİŞLİ PASOLU KÜRESEL VANA**



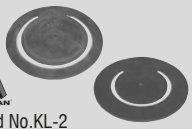

PN 6/16 Tam Geçişli-Dişi Küresel Vana Boyutları-Bağlantı Ölçüleri				
DN	L	h	G	
40 	1 1/2"	120	90	150
50 	2"	140	95	150
65	2 1/2"	145	132	220
80	3"	165	145	265
100	4"	185	155	275
125	5"	255	190	400
150	6"	255	210	425

**PIK DÖKÜMDEN TULUMBALAR - KUYU SİLİNDİRLERİ - LASTİKLER**

<b>MAVİ TULUMBA</b>		<b>2 no. 1 1/2"</b>	<b>3 no. 1 1/2"</b>	<b>4 no. 1 1/2"</b>	<b>5 no. 2"</b>				
 Kod No.T-1	MAVİ TULUMBA			1900,00	1900,00				
	KOL			225,00	225,00				
	KAPAK			315,00	315,00				
	VAS			270,00	270,00				
	PİSTON (Uzun Çubuk)			375,00	375,00				
<b>ÇANAK VAS TULUMBA</b>		<b>2 no. 1 1/2"</b>	<b>3 no. 1 1/2"</b>	<b>4 no. 1 1/2"</b>	<b>5 no. 2"</b>				
 Kod No.T-2	TULUMBA	1400,00	1500,00	1900,00	2500,00				
	KOL	150,00	150,00	225,00	225,00				
	KAPAK	180,00	195,00	285,00	315,00				
	ÇANAK VAS	375,00	420,00	525,00	600,00				
	PİSTON (Normal Çubuk)	300,00	350,00	400,00	450,00				
<b>DÜZ VAS TULUMBA</b>		<b>2 no. 1 1/2"</b>	<b>3 no. 1 1/2"</b>	<b>4 no. 1 1/2"</b>	<b>5 no. 2"</b>				
 Kod No.T-3	TULUMBA	1350,00	1450,00	1750,00	2000,00				
	DÜZ VAS	300,00	330,00	450,00	550,00				
<b>EMME BASMA TULUMBA</b>		<b>2 no. 1 1/2"</b>	<b>3 no. 1 1/2"</b>	<b>4 no. 1 1/2"</b>					
 Kod No.T-4		1950,00	2100,00	2400,00					
<b>GAĞALI TULUMBA</b>		<b>2 no. 1 1/2"</b>	<b>3 no. 1 1/2"</b>	<b>4 no. 1 1/2"</b>					
 Kod No.T-5		2100,00	2250,00	2700,00					
<b>KUYU SİLİNDİRİ</b>		<b>2 no. 1 1/2"</b>	<b>3 no. 1 1/2"</b>	<b>4 no. 1 1/2"</b>					
 Kod No.T-6		1350,00	1500,00	1650,00					
<b>TULUMBA LASTİĞİ</b>		<b>2 no. 1 1/2"</b>	<b>3 no. 1 1/2"</b>	<b>4 no. 1 1/2"</b>	<b>5 no. 2"</b>				
 Kod No.TL-1	TABAN LASTİĞİ	20,00	20,00	35,00	40,00				
	PİSTON LASTİĞİ	30,00	30,00	40,00	50,00				
	TULUMBA AĞIRLIĞI	50,00	50,00	60,00	70,00				
<b>KLEPE LASTİK - AĞIRLIK</b>		<b>1 1/4"</b>	<b>1 1/2"</b>	<b>2"</b>	<b>2 1/2"</b>	<b>3"</b>	<b>4"</b>	<b>5"</b>	<b>6"</b>
 Kod No.KL-2	KLAPE SÜZGEÇ LASTİĞİ		20,00	20,00	25,00	30,00	40,00	60,00	70,00
	DEMİR KLAPE LASTİKLERİ		30,00	35,00	45,00	50,00	75,00	100,00	120,00
	KLAPE AĞIRLIKLARI		50,00	50,00	70,00	80,00	100,00	150,00	200,00

DEVE BOYNU (PİK)		1"	1 1/4"	1 1/2"	2"	2 1/2"	3"	4"	5"	6"
 Kod No.P-1	BOYALI	110,00	140,00	180,00	200,00	300,00	400,00	600,00	1000,00	1300,00
	GALV.	130,00	170,00	220,00	240,00	380,00	500,00	750,00	1250,00	1600,00
	KOLİ ADET	40	40	30	25	20	15	10	5	5

FLANŞLI DEVE BOYNU (PİK)		1"	1 1/4"	1 1/2"	2"	2 1/2"	3"	4"	5"	6"
 Kod No.P-2	BOYALI				400,00	600,00	900,00	1200,00	1600,00	2000,00
	GALV.				510,00	750,00	1150,00	1550,00	2050,00	2600,00
	KOLİ ADET				10	8	6	5	4	4

AŞMAN SONDAJ KLEPESİ	2"	2 1/2"	3"
 Kod No.P-6	750,00	850,00	1000,00

ARA KLAPE (PİK)		1"	1 1/4"	1 1/2"	2"	2 1/2"	3"	4"	5"	6"
 Kod No.P-7				350,00	390,00	525,00	700,00	1000,00	1500,00	2000,00

SÜZGEÇ (TABAN KLAPE) (PİK)		1"	1 1/4"	1 1/2"	2"	2 1/2"	3"	4"	5"	6"
 Kod No.P-8				320,00	360,00	490,00	660,00	950,00	1450,00	1900,00

HORTUM REKORU (PİK)		1"	1 1/4"	1 1/2"	2"	2 1/2"	3"	4"	5"	6"
 Kod No.P-9	BOYALI		50,00	60,00	90,00	130,00	165,00	270,00	400,00	560,00
	GALV.		60,00	75,00	115,00	170,00	210,00	340,00	510,00	700,00
	KOLİ ADET		50	50	40	30	25	15	10	8

ÇİFT TARAFLI HORTUM REKORU (PİK)		1"	1 1/4"	1 1/2"	2"	2 1/2"	3"	4"	5"	6"
 Kod No.P-10	BOYALI			90,00	105,00	165,00	210,00	460,00	600,00	940,00
	GALV.			115,00	135,00	215,00	270,00	600,00	780,00	1200,00
	KOLİ ADET			25	20	15	10	12	8	4

TEL KELEPÇE		1"	1 1/4"	1 1/2"	2"	2 1/2"	3"	4"	5"	6"
 Kod No.K-1		45,00	50,00	55,00	60,00	65,00	70,00	75,00	80,00	90,00

HORTUMSAN KELEPÇE		1"	1 1/4"	1 1/2"	2"	2 1/2"	3"	4"	5"	6"
 Kod No.K-2		50,00	55,00	60,00	65,00	70,00	80,00	90,00	110,00	140,00

AYARLI SAÇ KELEPÇE		1"	1 1/4"	1 1/2"	2"	2 1/2"	3"	4"	5"	6"
 Kod No.K-3		70,00	75,00	80,00	85,00	90,00	95,00	100,00	125,00	140,00



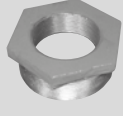

**PIK DÖKÜMDEN BORU EKLEME ve YÖNLENDİRME TEFERRUATLARI**

<b>NİPEL REDİKSİYON (PİK)</b>		2x1/2"	2x3/4"	2x1	2x1 1/4"	2x1 1/2"	2 1/2"x1	2 1/2"x1 1/4"	2 1/2"x1 1/2"	2 1/2"x2
 <p>Kod No.P-12</p>	BOYALI	75,00	75,00	70,00	65,00	60,00	105,00	100,00	95,00	90,00
	GALV.	95,00	95,00	85,00	80,00	75,00	125,00	120,00	115,00	110,00
	KOLİ ADET	50	50	50	60	60	40	40	40	50
		<b>3x1</b>	<b>3x1 1/4"</b>	<b>3x1 1/2"</b>	<b>3x2</b>	<b>3x2 1/2"</b>	<b>4x1</b>	<b>4x1 1/4"</b>	<b>4x1 1/2"</b>	<b>4x2</b>
	BOYALI	130,00	125,00	120,00	115,00	100,00	200,00	190,00	185,00	170,00
	GALV.	160,00	155,00	150,00	145,00	125,00	250,00	235,00	220,00	210,00
	KOLİ ADET	30	30	30	30	40	25	25	25	25
		<b>4x2 1/2"</b>	<b>4x3</b>	<b>5x2</b>	<b>5x2 1/2"</b>	<b>5x3</b>	<b>5x4</b>	<b>6x3</b>	<b>6x4</b>	<b>6x5</b>
	BOYALI	160,00	150,00	325,00	300,00	275,00	230,00	360,00	340,00	300,00
	GALV.	200,00	185,00	405,00	380,00	350,00	280,00	440,00	425,00	375,00
	KOLİ ADET	25	30	15	15	15	20	10	10	10

<b>TAPA (PİK)</b>		1/2"	3/4"	1"	1 1/4"	1 1/2"	2"	2 1/2"	3"	4"	5"	6"
 <p>Kod No.P-13</p>	BOYALI				35,00	45,00	55,00	75,00	95,00	140,00	200,00	340,00
	GALV.				45,00	55,00	70,00	90,00	120,00	175,00	250,00	430,00
	KOLİ ADET				100	80	80	60	50	30	20	10

<b>İÇTEN PASOLU TAPA (PİK)</b>		1"	1 1/4"	1 1/2"	2"	2 1/2"	3"	4"	5"	6"
 <p>Kod No.P-14</p>	BOYALI		45,00	55,00	65,00	95,00	105,00	165,00	250,00	350,00
	GALV.		55,00	70,00	80,00	105,00	135,00	205,00	310,00	440,00
	KOLİ ADET		80	60	60	50	40	25	15	10

<b>KONSANTRİK NİPEL (PİK)</b>		2x1 1/2"	2 1/2"x2	3x2	3x2 1/2"	4x3
 <p>Kod No.P-15</p>	BOYALI	90,00	120,00	135,00	150,00	225,00
	GALV.	110,00	145,00	165,00	180,00	335,00
	KOLİ ADET	50	40	30	30	20

<b>MANŞON REDİKSİYON (PİK)</b>		2x1 1/4"	2x1 1/2"	2 1/2"x1 1/2"	2 1/2"x2	3x1 1/2"	3x2	3x2 1/2"	4x1 1/2"	4x2
 <p>Kod No.P-16</p>	BOYALI	90,00	100,00	105,00	120,00	135,00	140,00	150,00	195,00	210,00
	GALV.	105,00	120,00	130,00	150,00	170,00	175,00	190,00	245,00	260,00
	KOLİ ADET	50	50	40	40	30	30	30	20	20
		<b>4x2 1/2"</b>	<b>4x3</b>	<b>5x4</b>	<b>6x4</b>	<b>6x5</b>				
	BOYALI	220,00	225,00	315,00	340,00	375,00				
	GALV.	280,00	285,00	395,00	430,00	465,00				
KOLİ ADET	20	20	15	10	10					

<b>NİPEL MANŞON REDİKSİYON (PİK)</b>		2x1 1/2"	2 1/2"x1 1/2"	2 1/2"x2	3x2	3x2 1/2"	4x2 1/2"	4x3	5x4	6x4	6x5
 <p>Kod No.P-17</p>	BOYALI	90,00	120,00	135,00	150,00	165,00	205,00	210,00	250,00	360,00	390,00
	GALV.	110,00	150,00	165,00	180,00	205,00	285,00	270,00	350,00	450,00	490,00
	KOLİ ADET	50	40	40	30	30	20	20	15	10	10

**PİSLİK TUTUCU - DALGIÇ VANASI - DAMLAMA VANASI**

PN 16 Y TİPİ FLANÇLI PİSLİK TUTUCU		40	50	65	80	100	125	150
 Kod No.V-1	GG-20	1900,00	2000,00	3800,00	4100,00	5200,00	7000,00	8800,00
	GGG-50	2100,00	2200,00	4200,00	4600,00	5800,00	8000,00	9800,00

DÜZ VANA	2"	2 <sup>1/2</sup> "	3"	4"	5"	6"
 Kod No.V-2	1700,00	3000,00	3400,00	4200,00	6200,00	9800,00

TOPRAK ALTI VANASI	2"	2 <sup>1/2</sup> "	3"	4"	5"	6"
 Kod No.V-3	1900,00	3200,00	3600,00	4500,00	6500,00	10.200,00

TE VANA	2"	2 <sup>1/2</sup> "	3"	4"	5"	6"
 Kod No.V-4	1700,00	2000,00	2300,00	3000,00	3600,00	6000,00

DİŞLİ İSTAVROZ VANA	2"	2 <sup>1/2</sup> "	3"	4"	5"	6"
 Kod No.V-5		3500,00	4200,00	5250,00	6750,00	9750,00

FLANÇLI İSTAVROZ VANA	2"	2 <sup>1/2</sup> "	3"	4"	5"	6"
 Kod No.V-6		5400,00	7000,00	8200,00	9800,00	13.000,00

KELEBEK VANA	2"	2 <sup>1/2</sup> "	3"	4"	5"	6"
	1100,00	1400,00	1700,00	2300,00	2800,00	3700,00
	8"	10"				
 Kod No.V-7	10.000,00	16.000,00				

# DİP KLAPE - TOPLU ÇEKVALF

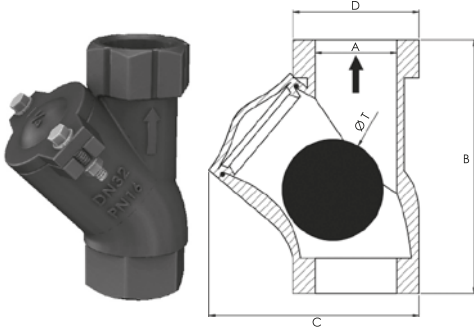

DİŞLİ TİP TOPLU ÇEKVALFLER THREADED TYPE BALL CHECK VALVES									
ÜRÜN KODU Product Code	ÖLÇÜ Size		BOYUTLAR Dimensions					AĞIRLIK (kg) Weight	Fiyat (TL)
	DN	INCH	A (mm)	B (mm)	C (mm)	D (mm)	ØT (mm)		
ORT-CVT32	DN32	1¼"	39	138	102	51	44	1,4	<b>900,00</b>
ORT-CVT40	DN40	1½"	40	150	120	70	53	2,1	<b>1.350,00</b>
ORT-CVT50	DN50	2"	50	180	140	82	60	3,2	<b>1.500,00</b>
ORT-CVT65	DN65	2½"	65	205	180	100	80	4,6	<b>2.200,00</b>

- \* Sfero döküm gövde / Ductile iron body
- \* NBR veya fenolik top / NBR or phenolic ball
- \* Yatay veya dikey kullanım / Horizontal or vertical use

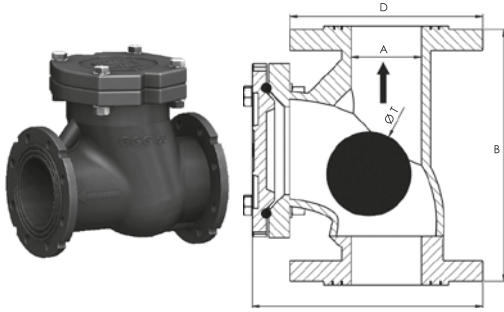



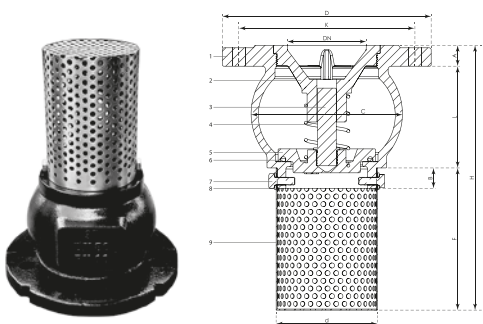
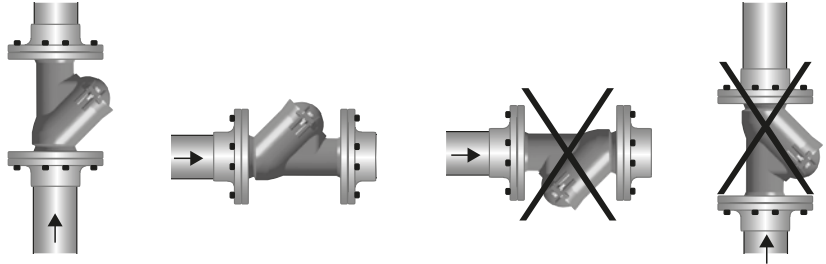







FLANŞLI TİP TOPLU ÇEKVALFLER FLANGED TYPE BALL CHECK VALVES									
ÜRÜN KODU Product Code	ÖLÇÜ Size		BOYUTLAR Dimensions					AĞIRLIK (kg) Weight	Fiyat (TL)
	DN	INCH	A (mm)	B (mm)	C (mm)	D (mm)	ØT (mm)		
ORT-CVTF50	DN50	2"	50	200	192	167	60	9,8	<b>3.400,00</b>
ORT-CVTF65	DN65	2½"	65	240	215	187	80	13,6	<b>4.850,00</b>
ORT-CVTF80	DN80	3"	85	265	235	200	94	18,3	<b>6.250,00</b>
ORT-CVTF100	DN100	4"	90	310	285	220	100	25,9	<b>9.000,00</b>
ORT-CVTF125	DN125	5"	125	344	340	250	150	40	<b>16.300,00</b>
ORT-CVTF150	DN150	6"	155	394	410	285	178	65	<b>21.500,00</b>



DİP KLAPE FOOT VALVES Yağmur suyu ve atık su uygulamaları Storm Water and Wastewater Applications									
NO	ÜRÜN PRODUCT	MALZEMELER MATERIALS	DN	80	100	125	150		
1	GÖVDE BODY	EN-GJS-400 SFERO DÖKÜM / SFERO CASTING	L	99,50	122,50	151	171		
2	MİL YATAĞI SHAFT BEARING	EN-GJS-400 SFERO DÖKÜM / SFERO CASTING	H	259	294	373,50	413		
3	MİL SHAFT	1.0503 - AISI 1050	d	99	121	141	171,50		
4	YAY COIL	1.4310 - AISI 302 PASLANMAZ ÇELİK / STAINLESS STEEL	A	20,50	21,50	22,50	22		
5	KLAPE CLAMP	EN-GJS-400 SFERO DÖKÜM / SFERO CASTING	F	139	150	200	220		
6	O-RING O-RING	NBR	B	20	24,50	26	29,50		
7	CIVATA BOLT	MBX15 - 933 A2 PASLANMAZ ÇELİK / STAINLESS STEEL	C	147,98	182,99	209,95	240,97		
8	PUL PLAIN WASHER	MB - 125 A2 PASLANMAZ ÇELİK / STAINLESS STEEL	K	159,75	179,50	209,75	240		
9	FİLTRE FILTER	1.4301 - AISI 304 PASLANMAZ ÇELİK / STAINLESS STEEL	D	204,25	225,25	252	290		

ÖLÇÜ		FİYAT (TL)
DN	İNÇ	
80	3"	5.850,00
100	4"	8.000,00
125	5"	14.250,00
150	6"	18.100,00

**BORUDAN İMAL HORTUM REKORLARI - UZATMALAR - ADAPTÖRLER**

GALVANİZ HORTUM REKORU		1/2"	3/4"	1"	1 1/4"	1 1/2"	2"	2 1/2"	3"	4"	5"	6"
	Kod No.D-1	30,00	33,00	40,00	52,00	57,00	77,00	105,00	135,00	215,00	435,00	530,00
BORU NİPEL		1/2"	3/4"	1"	1 1/4"	1 1/2"	2"	2 1/2"	3"	4"	5"	6"
	Kod No.D-2		40,00	45,00	50,00	55,00	60,00	90,00	110,00	170,00		
DİREK GEÇİŞLİ HORTUM REKORU		1/2"	3/4"	1"	1 1/4"	1 1/2"	2"	2 1/2"	3"	4"	5"	6"
	Kod No.D-3	28,00	30,00	38,00	50,00	55,00	76,00	103,00	133,00	205,00		
ÇİFT TARAFLI HORTUM REKORU		1/2"	3/4"	1"	1 1/4"	1 1/2"	2"	2 1/2"	3"	4"	5"	6"
	Kod No.D-4	46,00	51,00	69,00	84,00	99,00	128,00	160,00	207,00	340,00	400,00	560,00
BORU UCU (SİYAH)		1/2"	3/4"	1"	1 1/4"	1 1/2"	2"	2 1/2"	3"	4"	5"	6"
	Kod No.D-5	18,00	20,00	24,00	32,00	36,00	48,00	60,00	80,00	130,00	200,00	250,00
DAMLAMA ADAPTÖRÜ		1 1/2"	2"	2 1/2"	3"	4"	5"	6"				
	Kod No.D-6	105,00	125,00	150,00	175,00	240,00						
DAMLAMA REKORU		1 1/2"	2"	2 1/2"	3"	4"	5"	6"				
	Kod No.D-7	110,00	125,00	155,00	185,00	250,00						
DEMİR TE		1/2"	3/4"	1"	1 1/4"	1 1/2"	2"	2 1/2"	3"	4"	5"	6"
	Kod No.D-8					135,00	192,00	260,00	350,00	650,00		
DEMİR İSTAVROZ		1/2"	3/4"	1"	1 1/4"	1 1/2"	2"	2 1/2"	3"	4"	5"	6"
	Kod No.D-9					175,00	270,00	390,00	500,00	900,00		
DEMİR DEVE BOYNU		1/2"	3/4"	1"	1 1/4"	1 1/2"	2"	2 1/2"	3"	4"	5"	6"
	Kod No.D-10			130,00	160,00	177,00	247,00	365,00	457,00	745,00	1275,00	1725,00
BORU UZATMA ÇEŞİTLERİ (GALVANİZ)		1/2"	3/4"	1"	1 1/4"	1 1/2"	2"	2 1/2"	3"	4"	5"	6"
	20 cm.											
	25 cm.											
	30 cm.											
	40 cm.											
	50 cm.											
	75 cm.											
Kod No.D-11	100 cm.											

**FİYAT SORUNUZ**

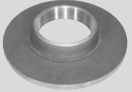
DEMİR FLANÇ (PASOLU)	1 1/2" (Ø140)	2" (Ø160)	2 1/2" (Ø185)	3" (Ø200)	4" (Ø220)	5" (Ø250)	6" (Ø280)
 Kod No.D-12	230,00	240,00	280,00	325,00	400,00	530,00	580,00

DEMİR FLANÇ (PASOLU - DELİKLİ)	1 1/2" (Ø140)	2" (Ø160)	2 1/2" (Ø185)	3" (Ø200)	4" (Ø220)	5" (Ø250)	6" (Ø280)
 Kod No.D-13	250,00	260,00	300,00	360,00	425,00	555,00	615,00

DEMİR ARA KLAPE	1 1/2"	2"	2 1/2"	3"	4"	5"	6"
 Kod No.D-14	700,00	750,00	900,00	1100,00	1300,00	2000,00	2500,00

DEMİR TABAN KLAPE (SÜZGEÇ)	1 1/2"	2"	2 1/2"	3"	4"	5"	6"
 Kod No.D-15	850,00	1000,00	1100,00	1300,00	1600,00	2500,00	3000,00

BORULU DEMİR KLAPE	1 1/2"	2"	2 1/2"	3"	4"	5"	6"
 Kod No.D-16	1300,00	1450,00	1750,00	1900,00	2250,00	3000,00	3750,00

SANTRAFÜJ KLAPESİ	1 1/2"	2"	2 1/2"	3"	4"	5"	6"
 Kod No.D-17				750,00	900,00	1700,00	2000,00

SAÇ DİP KLAPE (REKORLU)	2"	2 1/2"	3"	4"	5"
	650,00	700,00	750,00	1000,00	1200,00
	6"	8"	10"	12"	
1300,00	3200,00	9500,00			

DEMİR TULUMBA	3 No
 Kod No.D-19	1200,00

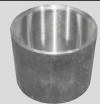
SİYAH MANŞON	1/2"	3/4"	1"	1 1/4"	1 1/2"	2"	2 1/2"	3"	4"	5"	6"
 Kod No.D-20	12,00	16,00	23,00	32,00	40,00	85,00	105,00	125,00	220,00	310,00	375,00

GALVANİZ MANŞON	1/2"	3/4"	1"	1 1/4"	1 1/2"	2"	2 1/2"	3"	4"	5"	6"
 Kod No.D-21	16,00	25,00	30,00	40,00	50,00	100,00	125,00	150,00	250,00	350,00	450,00

PATENT DİRSEK	1/2"	3/4"	1"	1 1/4"	1 1/2"	2"	2 1/2"	3"
	35,00	40,00	44,00	78,00	82,00	130,00	230,00	290,00
	4"	5"	6"	8"	10"	12"	14"	16"
440,00	760,00	1060,00	2000,00	5000,00	9000,00			

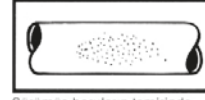

**ÇABUK TAMİR PARÇASI (Ç.T.P.)****KULLANILDIĞI YERLER ve MONTAJ ŞEKLİ**

Çürümüş boruların tamirinde

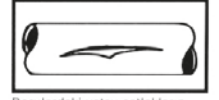

Borulardaki yatay çatlakların tamirinde

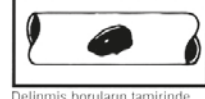

Delinmiş boruların tamirinde



Borulardaki dikey çatlakların tamirinde

- GG20 - GGG40 normlarında imal edilir. • Paslanmaya karşı 8,8 kalitesinde Civata ve Somunlar kullanılmaktadır.
- -20°C – -100°C'de kalitesi bozulmayan özel kauçuktan imal edilmiş EPAM contalıdır. • ALMAN İNGİLİZ BS - TÜRKİYE TSE normlarında imal edilen PVC - ASBEST - DİKİŞLİ ÇELİK ve DÖKÜM boruların dış çaplarına göre imal edilmiştir. • İşletme basıncı 16 bar'dır. • ½" ten 10" kadar imal edilen çabuk tamir parçaları EPOKSY boyalıdır.

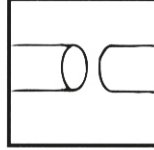
**BORU EK PARÇASI (B.E.P.)****KULLANILDIĞI YERLER ve MONTAJ ŞEKLİ**

Boruları karşılıklı getirin. Ek parçasının civatalarını sokun.

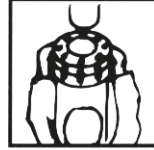

Ek parçasını borunun tekine geçirin.

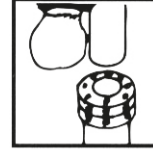

Diğer boruyu ek parçasının içine geçirin.



Karşılıklı civataları sıkın.

- PVC boruları, Çelik ve Asbest boruları • PVC - Asbest ve Çelik boruları Savurma Döküm boruları ekler • Kaynak - Kurşun kalafat gerektirmez • Özel contası esnek bağlantı sağlar • Sadece anahtar ile monte edilir • Hafiftir, özel taşıma araçları gerektirmez • Montajı kolaydır, kalifiye eleman gerektirmez • Eklenecek boruların ağız ağza gelme şartı yoktur. a 15°'ye kadareksenden kaçık boruları rahatlıkla ekler • Su şebekesindeki basıncın kesilmesi halinde özel contası sayesinde pis suları şebeke içine almaz.

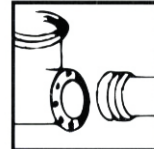
**BORU VANA BAĞLANTI PARÇASI (B.V.P.)****KULLANILDIĞI YERLER ve MONTAJ ŞEKLİ**

Boruyu vanaya karşı getirin.

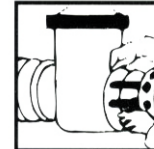

Bağlantı parçasının civatalarını sökün.



Önce flanşı vanaya monte edin.

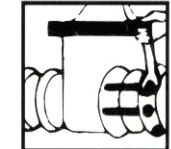

Karşılıklı civataları flanşa sıkın.

- Belediyelerin içme ve kullanma suyu şebekelerinde • Su arıtma tesislerinde • Gaz şebekelerinde • Endüstriyel tesislerde
- Gemi endüstrisinde • Petrol boru hatlarında • Petro Kimya tesislerinde • Hidro Elektrik tesislerinde • Soğuk Hava tesisatlarında
- Basıncılı Hava tesisatında ve Havalandırma tesisatlarında • Tuzlu Su tesisatında • Kimyevi madde üreten fabrikaların tesisatlarında
- Toz halindeki katı maddelerin boru tesisatında (Çimento - Un - Yem vs.)

**PRİZ KOLYE**

- Ana şebeke borusundan su almak amacıyla isteğe göre çıkışı ayarlanabilen, boruyu çevreleyen alt gövde ve üst gövdeyi civatalarla sıkıştırmak maksadıyla tasarlanmış kelepçedir • Kolyenin gövdesi isteğe göre GG25 - GGG40 normlarında imal edilmektedir • Sızdırmazlık kauçuk esanslı EPDM conta ile sağlanmaktadır • Su çıkışında isteğe göre o-ring conta veya çakma conta kullanılmaktadır • İşletme basıncı 16 bar'dır • Kullanılan civata somunlar 8,8 kalite ve galvaniz kaplıdır



1959-2024

Türkiye'nin her köşesinde  
mutlaka  
bir AŞMAN Döküm ürünü  
vardır.



**AŞMAN**<sup>®</sup>  
DÖKÜM SANAYİ VE TİCARET A.Ş.

Tel.:0232.782 60 01 / Fax:0232.782 70 03 / [www.asman.com.tr](http://www.asman.com.tr) / [info@asman.com.tr](mailto:info@asman.com.tr)

Her hakkı saklıdır. İzinsiz çoğaltılamaz, dağıtılamaz ve amacı dışında kullanılamaz.  
Copyright © 2022 Aşman Döküm Sanayi ve Ticaret A.Ş.

dijijSET